

JEFFERSON CONCRETE CORP.

22850 MURROCK CIRCLE
WATERTOWN, NY 13601
TEL (315)788-4171 FAX (315)788-7958
www.jeffersonconcrete.com

8 OUTLET DISTRIBUTION BOX

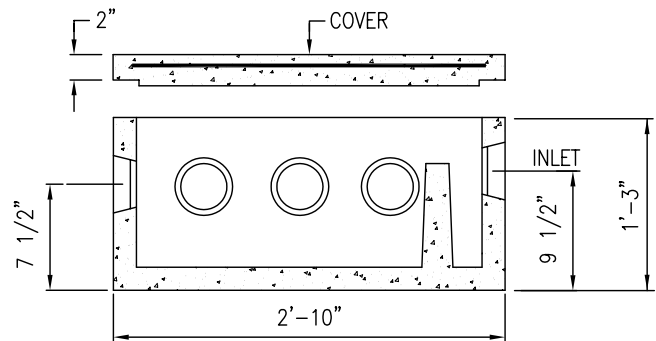
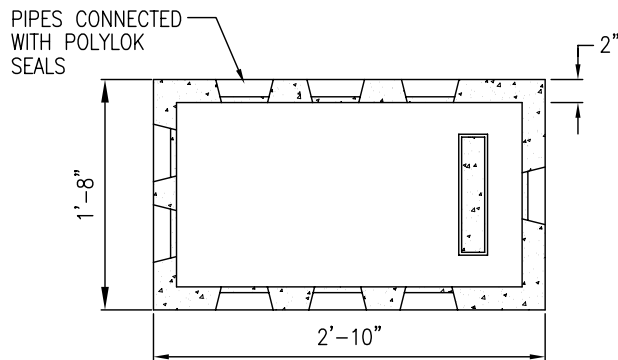
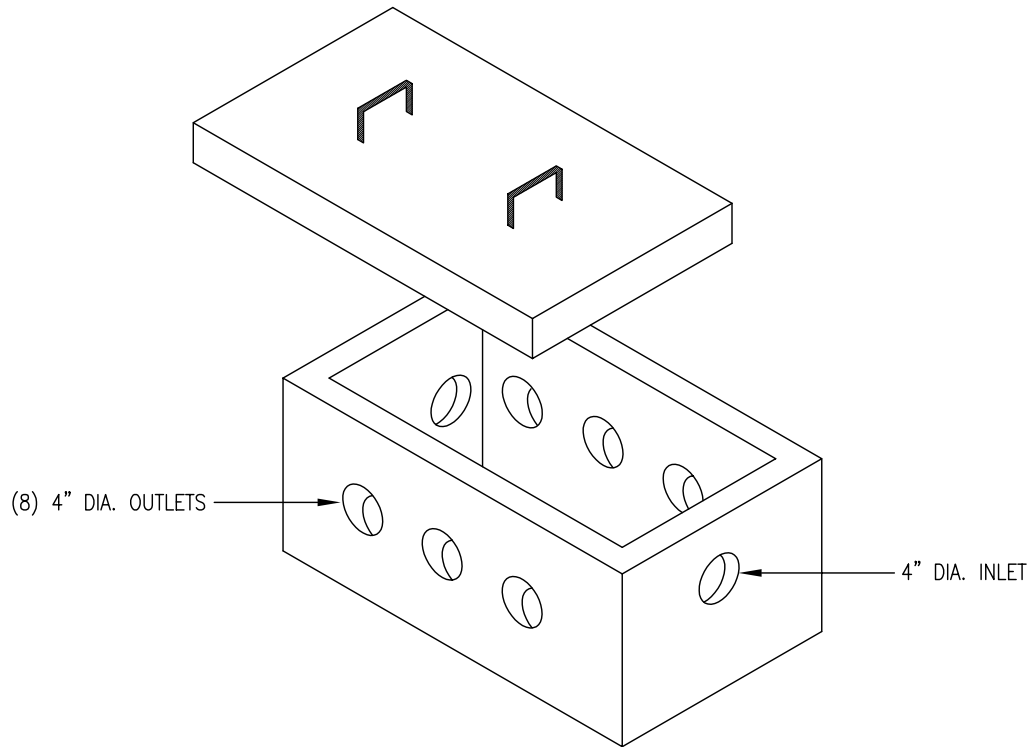

GENERAL NOTES:

CONCRETE TO BE MIN. 5000 PSI @ 28 DAYS
ENTRAINED AIR 5%-8%
STEEL REINFORCEMENT - ASTM A 615 GRADE 60
BUILT IN ACCORDANCE TO ASTM C-1227/C913 (300 PSF)

UPDATED 03/28/10